

4 Passo
Paso
Step

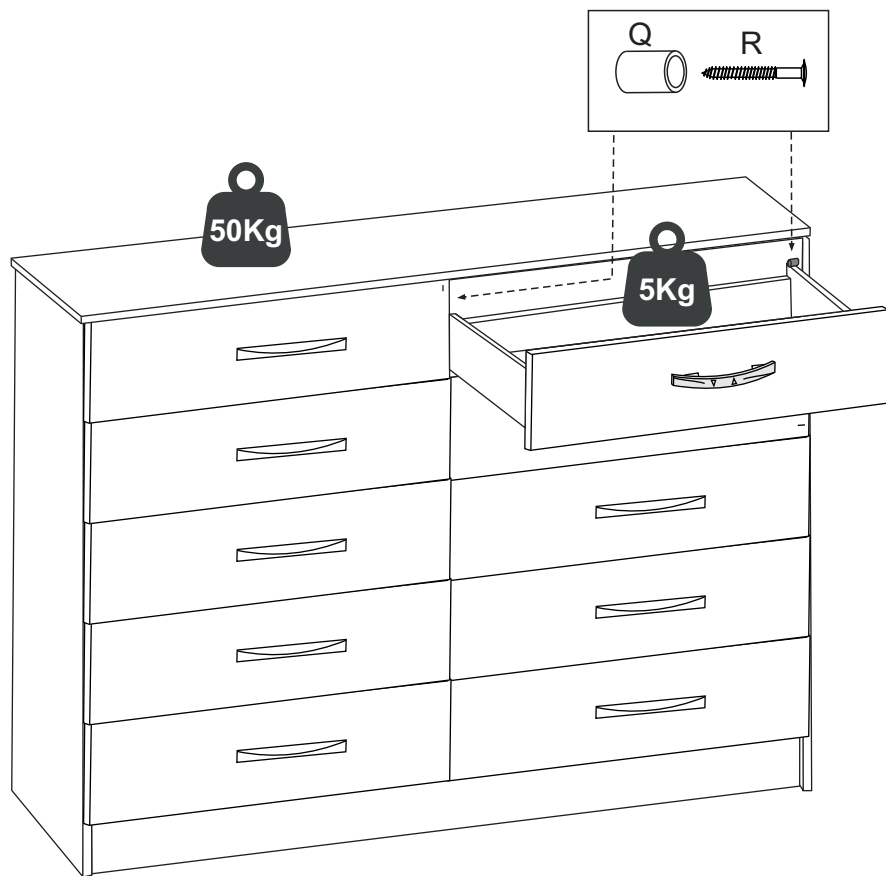

Evidência

Móveis

Cômoda Ref. 210

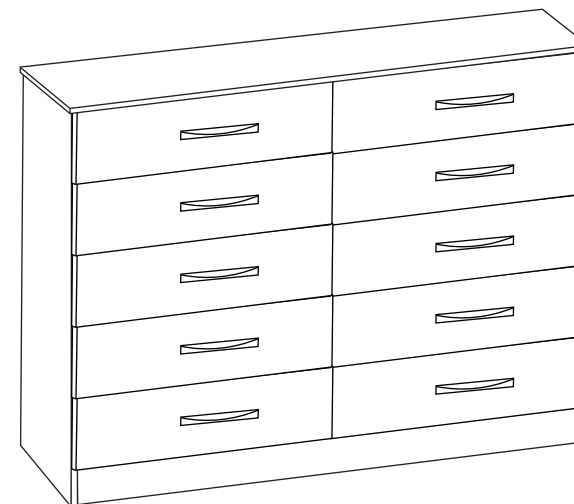



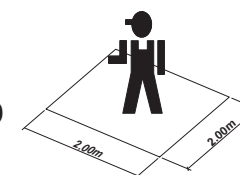









MANUAL DE MONTAGEM
INSTRUCCIONES DE ARMADO
ASSEMBLY INSTRUCTIONS



FERRAMENTAS NECESSÁRIAS
HERRAMIENTAS NECESARIAS
TOOLS NECESSARY

















 <input checked="" type="checkbox"/>	 <input type="checkbox"/>	 <input type="checkbox"/>	 <input type="checkbox"/>	 <input type="checkbox"/>	 <input type="checkbox"/>
Chave Phillips Pequena	Chave Phillips Pequena	Chave Fenda Pequena	Chave Fenda Pequena	Chave de Boca com XXmm	Furadeira com Broca de XXmm
 <input checked="" type="checkbox"/>	 <input checked="" type="checkbox"/>	 <input type="checkbox"/>	 <input type="checkbox"/>	 <input type="checkbox"/>	 <input type="checkbox"/>
Martelo Borracha	Martelo	Nível	Trena	Escada	Esquadro



Por favor, antes de começar a montagem verifique se você recebeu todos os componentes e peças do produto.

FERRAGENS/ HERRAJE/ HARDWARE

A	Parafuso 3,5 x 40 c/chata Tornillo Screw		10
B	Parafuso 3,5 x 25 c/flangeada Tornillo Screw		22
C	Cantoneira 18x18 Esquina Cantoneira		23
D	Cavilha 6 x 30 Clavija Wood Peg		48
E	Prego 13 x 15 Clavo 13 x 15 Nail 13 x 15		40
F	Prego 10 x 10 Clavo 10 x 10 Nail 10 x 10		50
H	Sapata L 40 mm Tirador Handle		4
J	Cola Pegamento Glue		1
M	Puxador 128 mm Tirador Handle		10
P	Corrediça plástica Rieles Slides		16
Q	Rolete Pino Rolete		4
R	Parafuso 3,5 x 20 c/flangeada Tornillo Screw		4
S	Parafuso 3,5 x 12 c/Chata Tornillo Screw		46
T	Porca Plástica 		4
U	Parafuso 3,5 x 25 c/chata Tornillo Screw		2



- Siga atentamente todas as instruções de montagem;
- Monte seu produto no local ou próximo de onde será colocado. Movimentações do produto já montado, podem avariá-lo;
- Faça a montagem em uma superfície limpa e plana. Aconselhamos usar a própria embalagem de papelão para forrar o chão;
- Verifique se as quantidades de peças e acessórios estão de acordo com o manual de montagem;
- Compare atentamente os furos de cada peça com a ilustração no manual;
- Utilize as ferramentas indicadas. Só utilize parafusadeira se tiver conhecimento e habilidade. O uso inadequado pode danificar peças e/ou acessórios;

3 Passo Paso Step

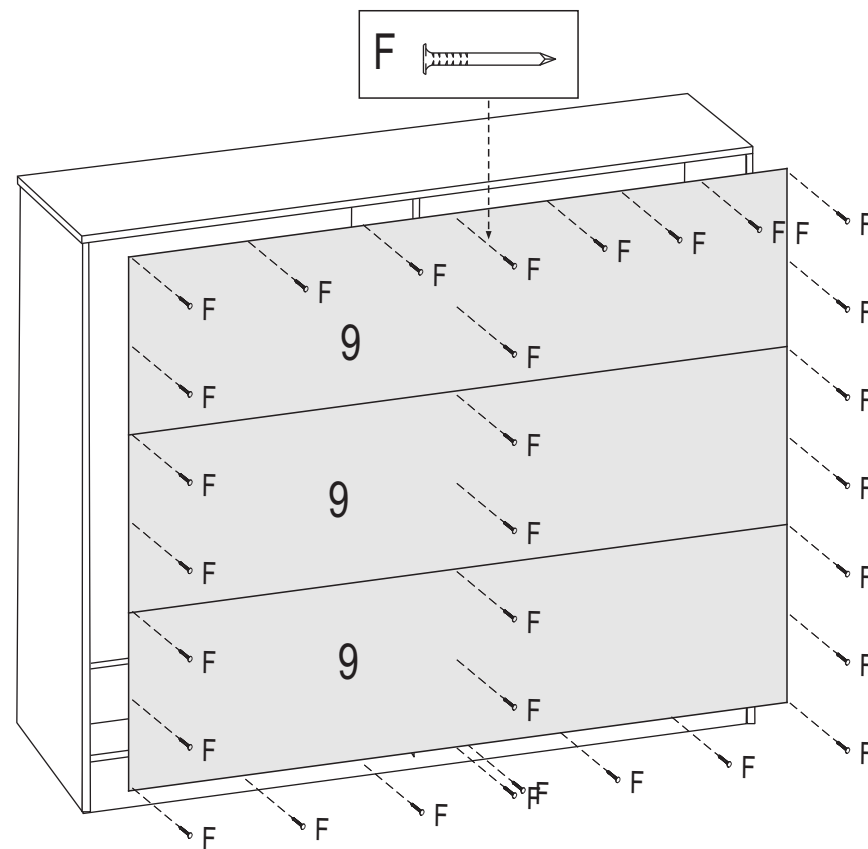

Cuidar para ficar no esquadro ao fixar os fundos para não ter problemas com as gavetas

2 Passo
Paso
Step

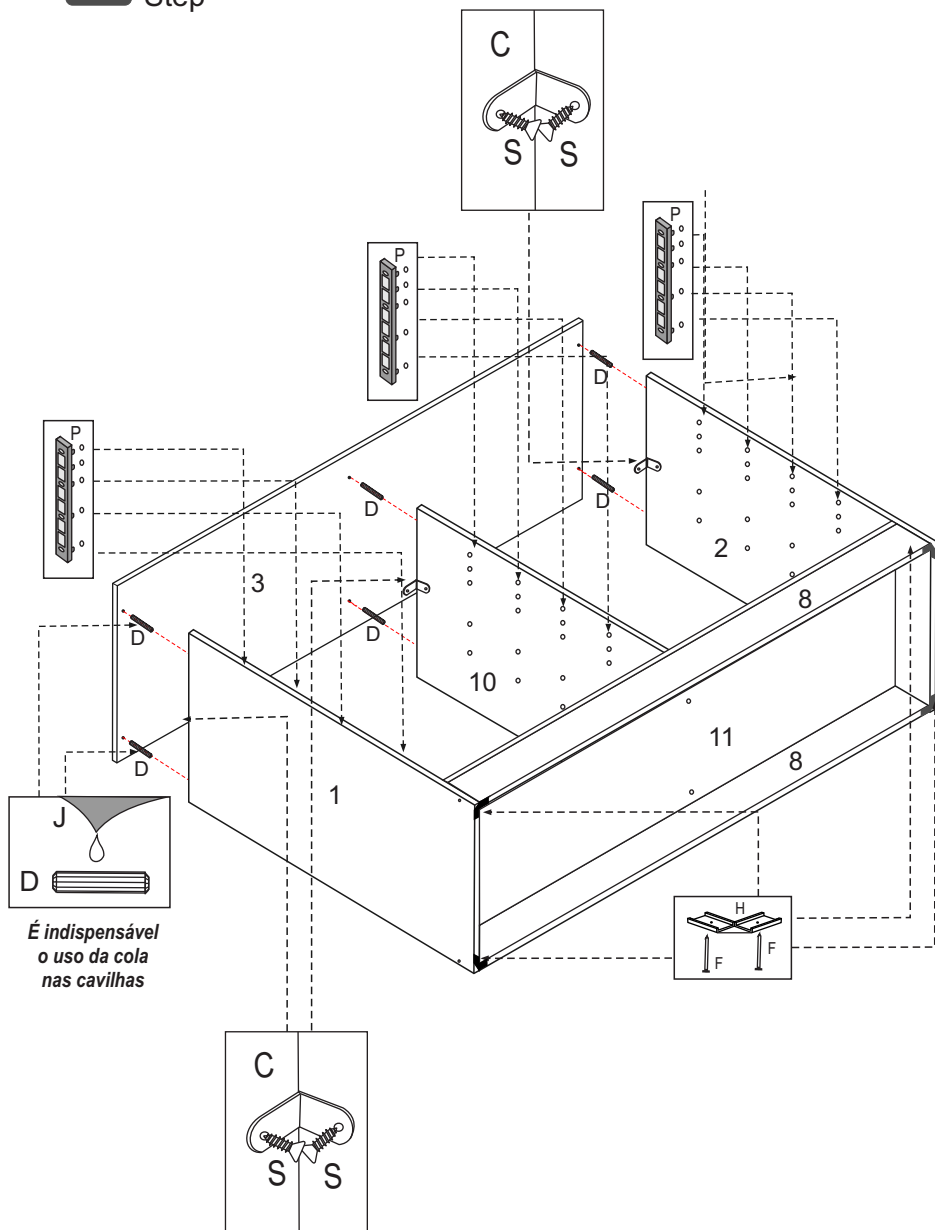

Peças do Produto:

Obs: Para solicitar assistência técnica, utilize o código da ferragem ou peça indicada

Cód.	Descrição da Peça	Unid.	Matéria Prima	Medida
1	Lateral esquerda / Lateral izquierda / Left side	01	MDP 15 mm	905 x 385
2	Lateral direita / Lateral derecha / Right side	01	MDP 15 mm	905 x 385
3	Tampo Superior / Tapa superior / Upper Top	01	MDP 15 mm	1230 x 405
4	Lateral gaveta / Lateral cajón / Drawer side	20	Pinus	350 x 105
5	Traseiro gaveta / Trasero cajón / Drawer back	10	MDP 12 mm	565 x 80
6	Frente gaveta / Frente cajón / Drawer front	10	MDP 15 mm	605 x 160
7	Fundo gaveta / Fondo cajón / Drawer bottom	10	MDP 3 mm	575 x 350
8	Rodapé / Travessaño / Crossbar	02	MDP 15 mm	1200 x 8
9	Costa / Dorso / Back panel	03	MDP 3 mm	1220 x 30
10	Divisória / Division / Divider	01	MDP 15 mm	810 x 385
11	Tampo inferior / Tapa inferior / Left Top	01	MDP 15 mm	1200 x 385

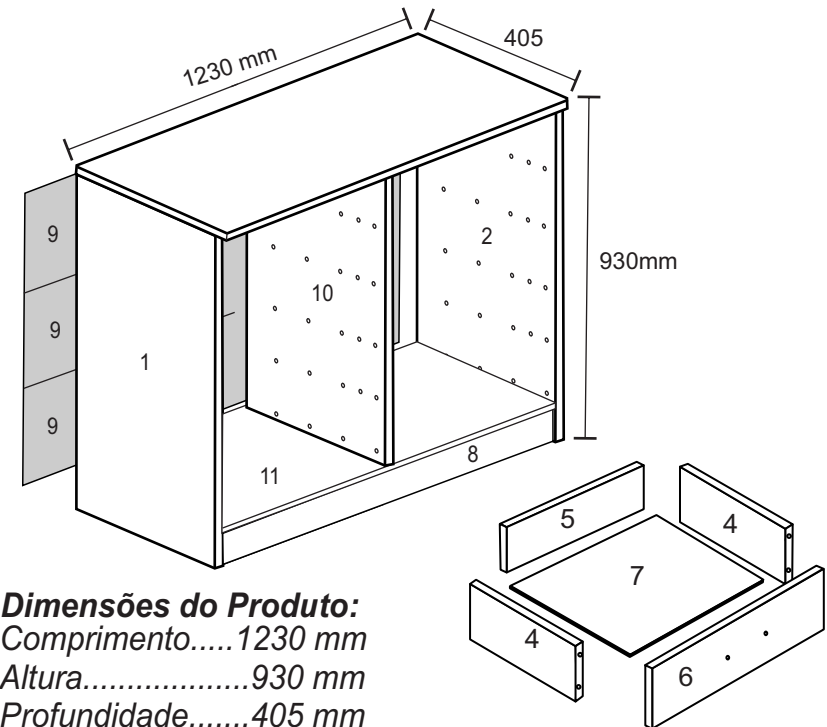

Dimensões do Produto:
Comprimento.....1230 mm
Altura.....930 mm
Profundidade.....405 mm

MONTAGEM GAVETA

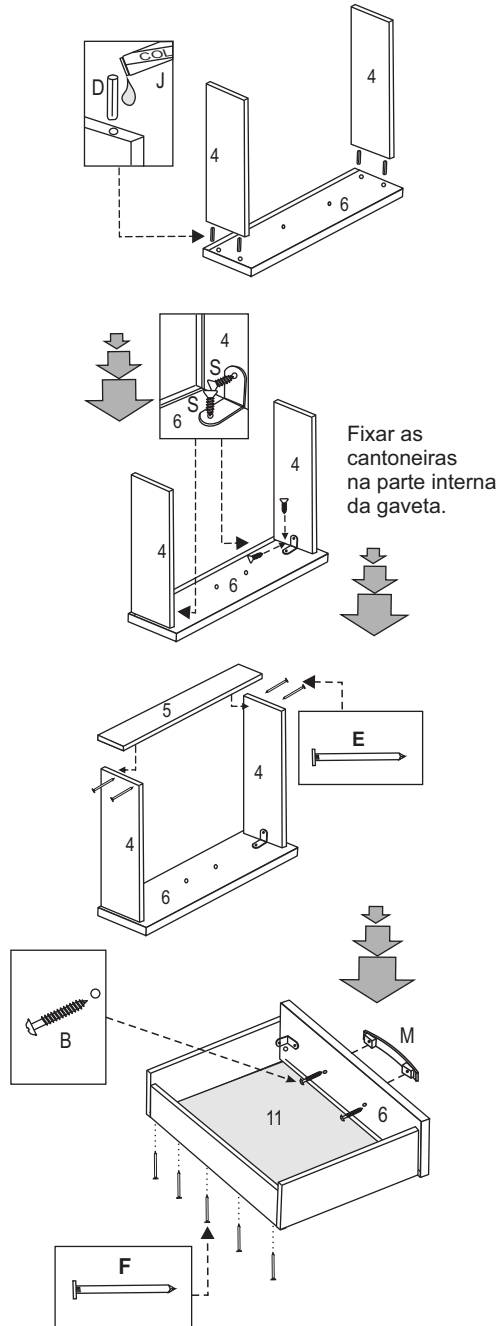

1 Passo
Paso
Step

